

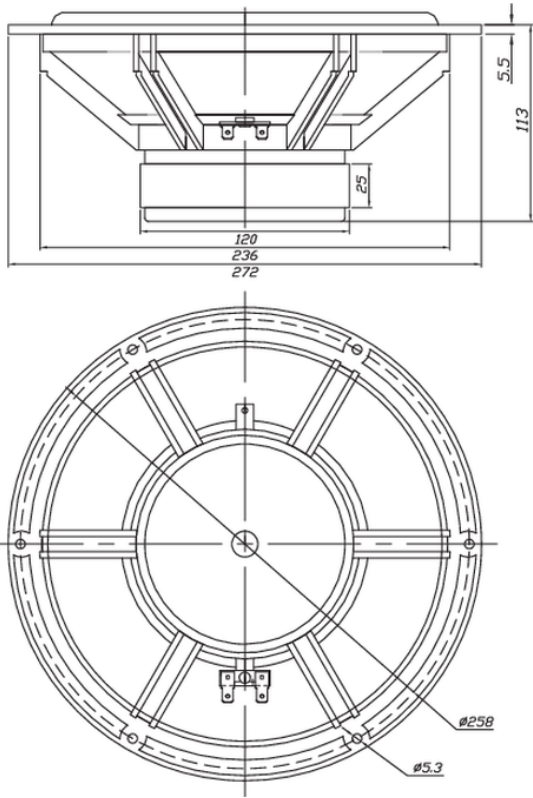

RS270-8 10" Reference Woofer 8 Ohm

RS270-8



PARAMETERS

Impedance	8 ohms
Re	6.8 ohms
Le	0.93 mH @ 1 kHz
Fs	29.6 Hz
Qms	2.08
Qes	0.61
Qts	0.47
Mms	50.5g
Cms	0.57 mm/N
Sd	346.4 cm ²
Vd	228.6 cm ³
BL	10.3 Tm
Vas	96.5 liters
Xmax	6.6 mm
VC Diameter	50 mm
SPL	88.7 dB @ 2.83V/1m
RMS Power Handling	100 watts
Usable Frequency Range (Hz)	27 - 2,040 Hz

FEATURES

- One of the lowest distortion, highest resolution driver series available
- Low-distortion high-excursion motor system with two short-circuit paths
- Compliant suspension and rigid black anodized aluminum cone for strong bass performance
- Heavy-duty 6-hole cast frame, low-loss rubber surround, and solid aluminum phase plug
- Designed and engineered in the USA

IMPEDANCE/PHASE

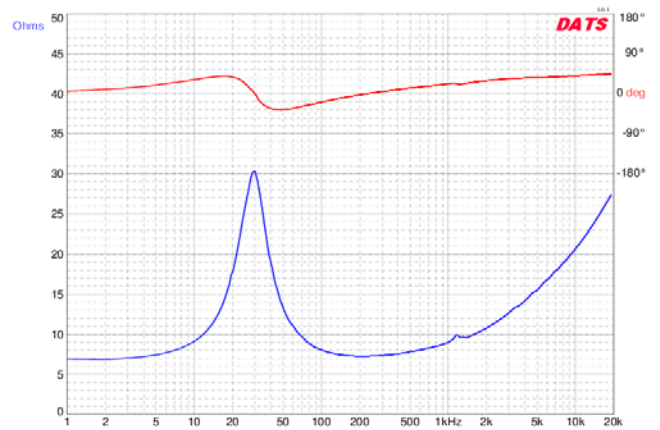

FREQUENCY RESPONSE

OMNIMIC

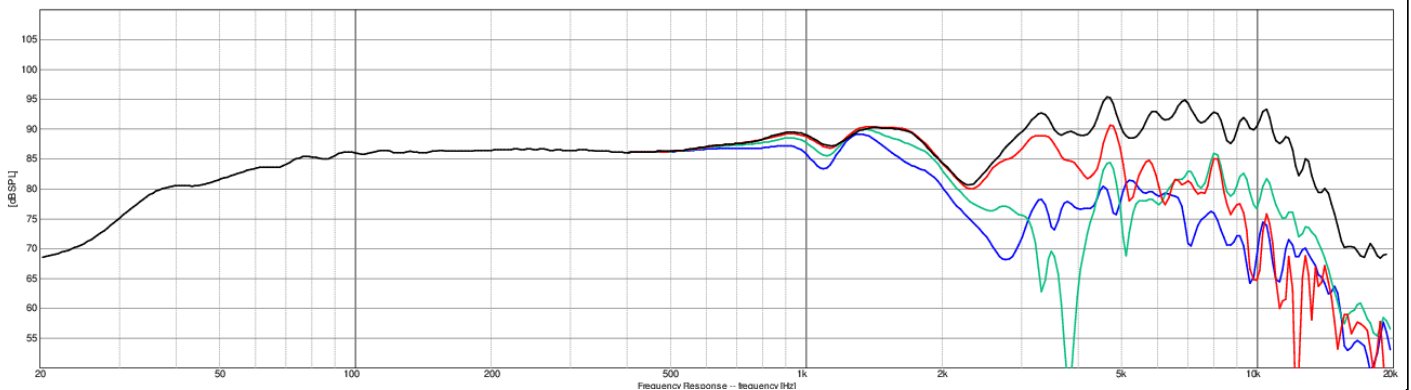

Note: 1/24th octave smoothing - nearfield response included in graph below 450 Hz.

Black = 0°
Red = 15°
Green = 30°
Blue = 45°