

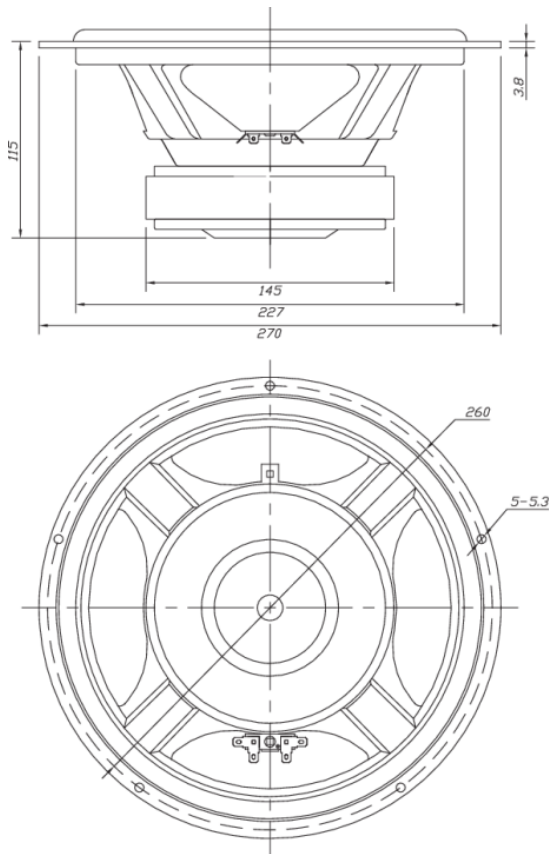

DA270-8 10" Aluminum Cone Woofer

DA270-8



PARAMETERS

Impedance	8 ohms
Re	6.3 ohms
Le	1.20 mH
Fs	27.8 Hz
Qms	1.95
Qes	0.55
Qts	0.43
Mms	51.3g
Cms	0.64 mm/N
Sd	346.4 cm ²
Vd	211.3 cm ³
BL	10.1 Tm
Vas	108.5 liters
Xmax	6.1 mm
VC Diameter	36 mm
SPL	88.2 dB @ 1W/1m
RMS Power Handling	80 watts
Usable Frequency Range (Hz)	25 - 6,000 Hz

FEATURES

- Great looking and sounding woofer
- One-piece aluminum cone
- Cosmetic stamped steel frame
- Flat frequency response in passband region
- Impressive output capabilities when used in MTM designs

IMPEDANCE/PHASE

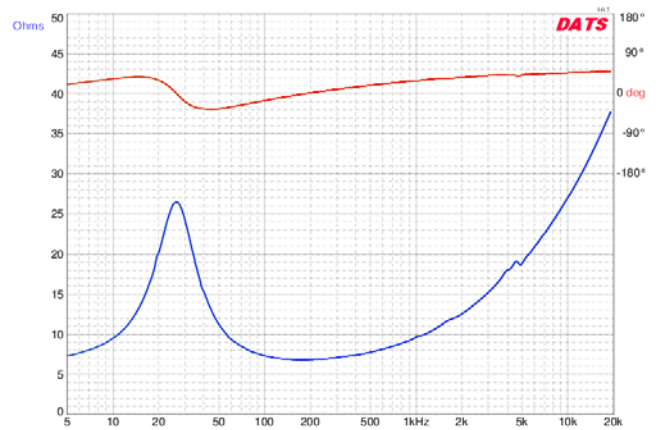

FREQUENCY RESPONSE

OMNIMIC

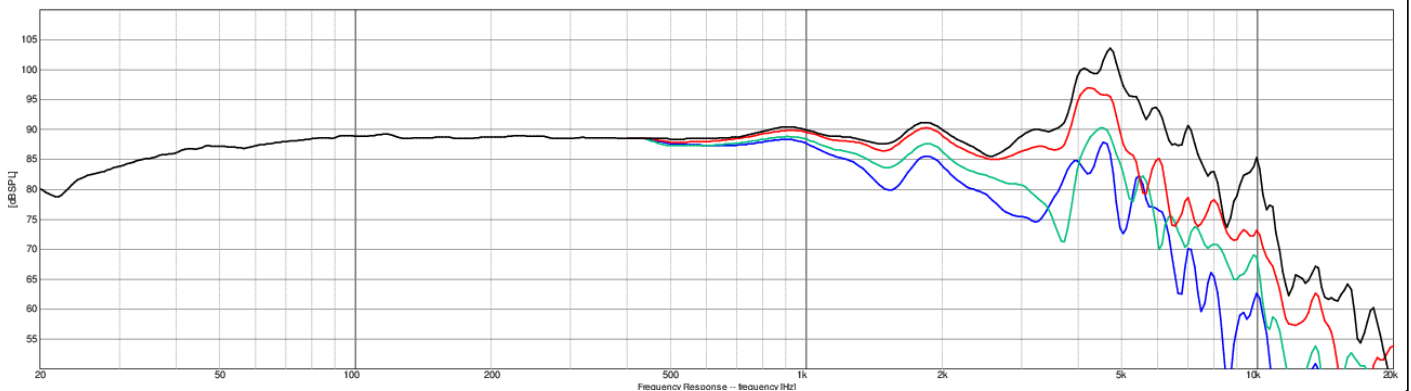

Note: 1/24th octave smoothing - nearfield response included in graph below 450 Hz.

Black = 0°
Red = 15°
Green = 30°
Blue = 45°