

Revelator 1" Tweeter



Type Number: D2904/710002

Features:

The Revelator series has for years been celebrated for producing the best sounding electro dynamic transducers in the world. Since ScanSpeak was founded in 1970, the audio engineers and R&D experts working on the line have been on a quest to create drivers that reveal all the sound in recordings, hiding nothing from the listener. This quest has resulted in several revolutionary inventions that remove distortion in the magnet systems and in the moving parts of the speaker. The philosophy is that the sound has to be very dynamic, giving a perfect transient response and providing tonal balance.



In the Revelator tweeters, additional enhancements have been made to reduce distortion and power compression, and to optimize airflow in the chambers, producing several unique tweeter designs.

Driver Highlights: 1" soft dome, SD-2 neodymium motor, non resonant aluminium chamber, multiple chamber low compression design, machined aluminium faceplate.

Specs:

Electrical Data

Nominal impedance	Zn 4 ohm	
Minimum impedance	Zmin 0.3 ohm	
Maximum impedance	Zo 23.9	ohm
DC resistance	Re 3 ohm	
Voice coil inductance	Le 0.01	mH

T-S Parameters

Resonance Frequency	fs 520	Hz
Mechanical Q factor	Qms --	
Electrical Q factor	Qes --	
Total Q factor	Qts --	
Force factor	Bl 2.8 Tm	
Mechanical resistance	Rms --	Kg/s
Moving mass	Mms 0.4 g	
Suspension compliance	Cms 0.27 mm/N	
Effective cone diameter	D --	cm
Effective piston area	Sd 7 cm	²
Equivalent volume	Vas --	ltrs
Sensitivity (2.83V/1m)	94.4	dB

Power handling

Long-term Max Power (IEC 18.3)	-- W
Short Term Max power (IEC 18.2)	-- W

Voice Coil and Magnet Parameters

Voice coil diameter	25 mm
Voice coil height	2.1 mm
Voice coil layers	2
Height of the gap	2.5 mm
Linear excursion +/-	0.2 mm
Max mech. excursion +/-	1.6 mm
Flux density of gap	-- mWb
Total useful flux	-- mWb
Diameter of magnet	-- mm
Height of magnet	-- mm
Weight of magnet	-- Kg

Notes:
IEC specs refer to IEC 60268-5 third edition.
All ScanSpeak products are RoHS compliant.

Frequency: D2904/710002

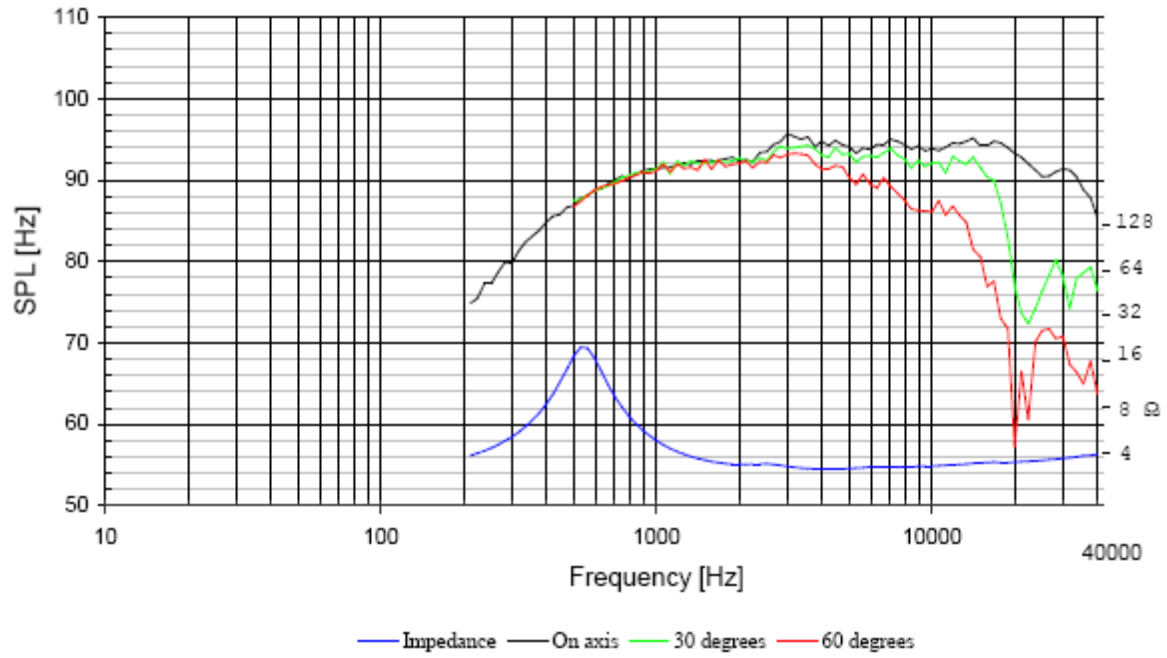

Mechanical Dimensions:D2904/710002

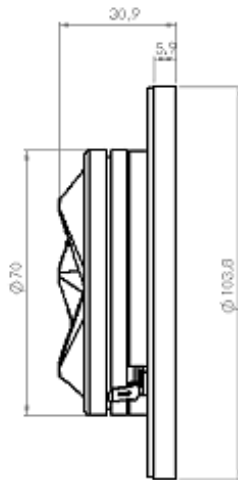
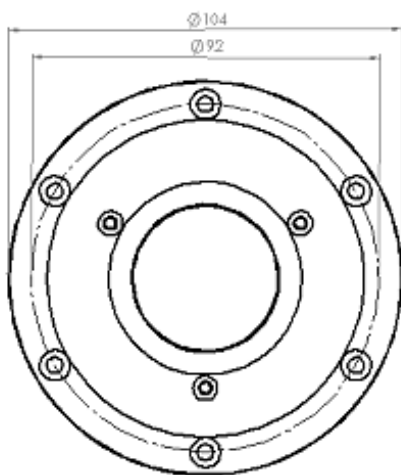

- Drawing Dimensions**
- Outside Diameter
 - Flange Thickness
 - Magnet Diameter
 - Cutout Diameter
 - Interior Depth
 - Hole Diameter
 - Screw Circle Diameter